

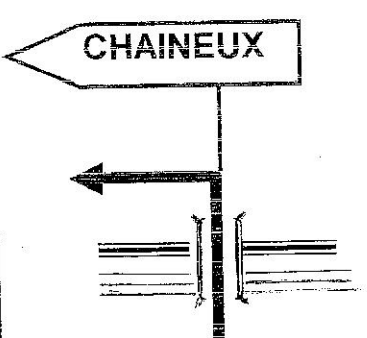

Dimanche 19 juillet 2009

Voiture balai GSM 0496 50 48 06

<p>4</p>  <p>1400      4400</p>	<p>8</p>  <p>1300      8800</p>	<p>12</p>  <p>100      11500</p>
<p>3</p>  <p>2700      3000</p>	<p>7</p>  <p>500      7500</p>	<p>11</p>  <p>1400      11400</p>
<p>2</p>  <p>300      300</p>	<p>6</p>  <p>600      7000</p>	<p>10</p>  <p>1000      10000</p>
<p>1</p>  <p>2000</p>	<p>5</p>  <p>6400</p>	<p>9</p>  <p>200      9000</p>

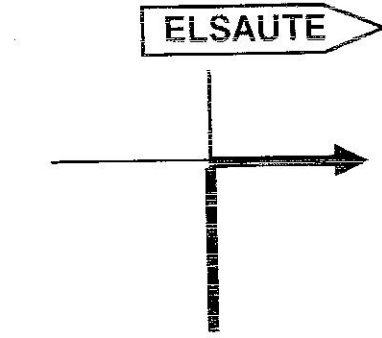
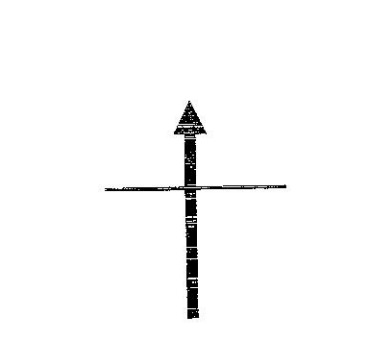
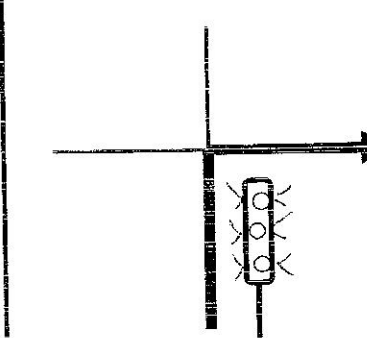
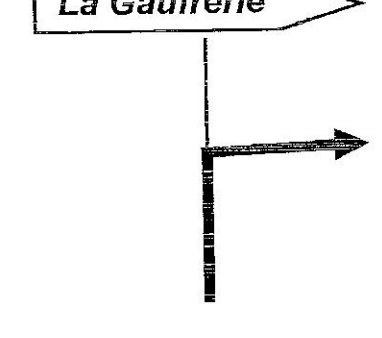
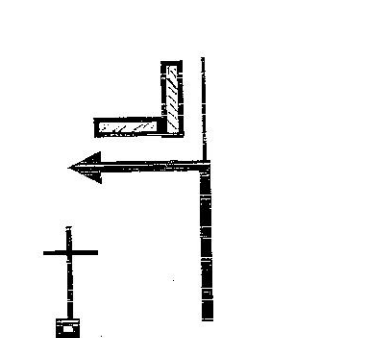
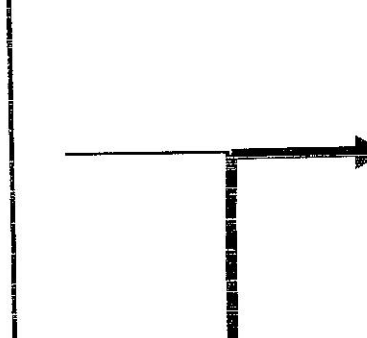
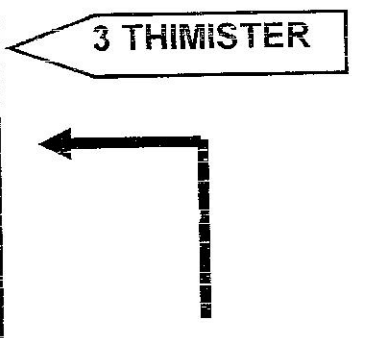
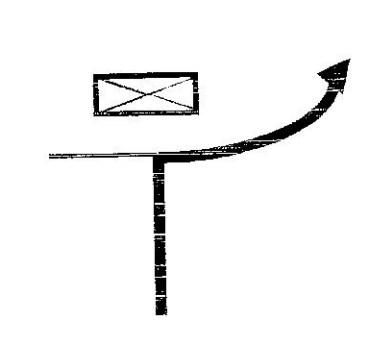
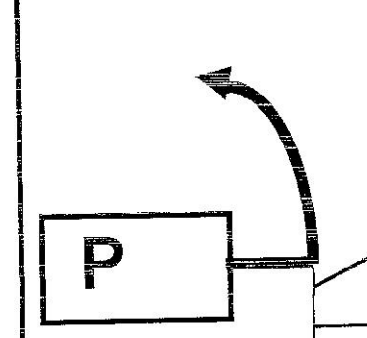
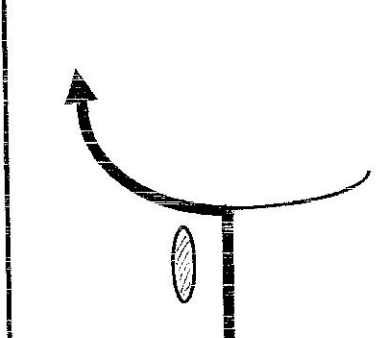
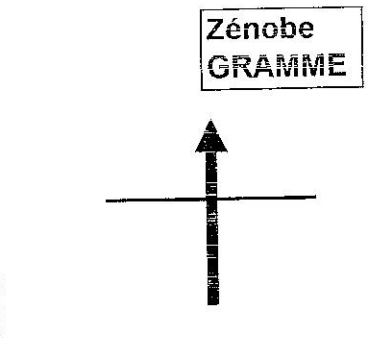

Dimanche 19 juillet 2009

Voiture balai GSM 0496 50 48 06

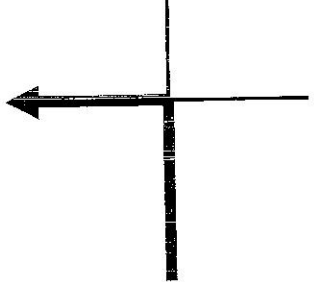
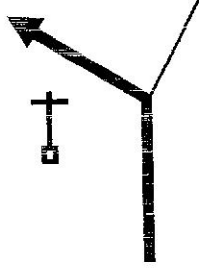
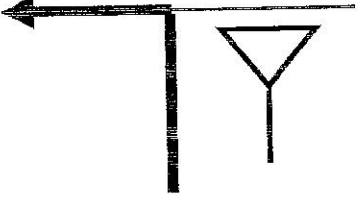
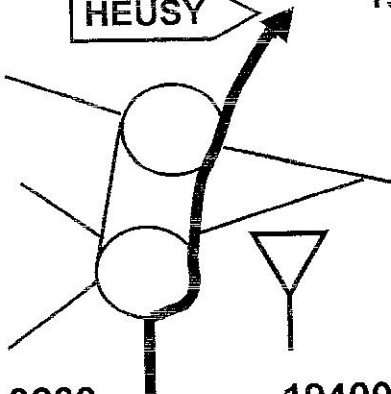
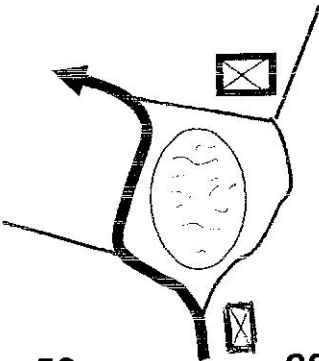
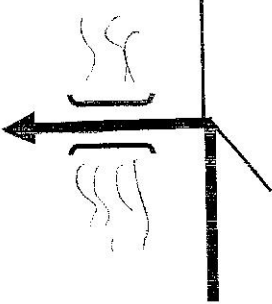
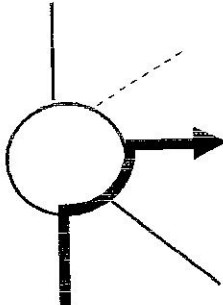
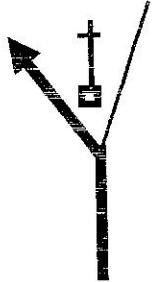
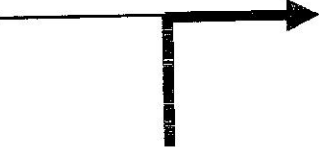
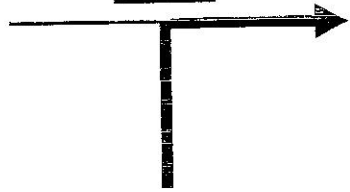
<p>16</p> <p>R.S.P.</p> <p>100</p>	<p>20</p> <p>Rue Grand - Vinave</p>  <p>19500</p>	<p>24</p> <p>Chemin de la Lande</p>  <p>400</p> <p>20400</p>
<p>15</p>  <p>200</p> <p>13700</p>	<p>19</p> <p>HEUSY</p>  <p>3200</p> <p>19400</p>	<p>23</p>  <p>50</p> <p>20000</p>
<p>14</p>  <p>300</p> <p>13500</p>	<p>18</p>  <p>2500</p> <p>16200</p>	<p>22</p>  <p>50</p> <p>19950</p>
<p>13</p> <p>USINES</p>  <p>1700</p> <p>13200</p>	<p>17</p>	<p>21</p> <p>rue LELOTTE</p> <p>21</p>  <p>400</p> <p>19900</p>



Dimanche 19 juillet 2009

Voiture balai GSM 0496 50 48 06

<p>28</p> <p>1100      22700</p>	<p>32</p> <p>400      26100</p>	<p>36</p> <p>2100      32300</p>
<p>27</p> <p>400      21600</p>	<p>31</p> <p>1100      25700</p>	<p>35</p> <p>600      30200</p>
<p>26</p> <p>200      21200</p>	<p>30</p> <p>2000      24600</p>	<p>34</p> <p>3500      29600</p>
<p>25</p> <p>600      21000</p>	<p>29</p>	<p>33</p>



Dimanche 19 juillet 2009

Voiture balai GSM 0496 50 48 06

<p>40</p> <p>Royal GOLF</p> <p>2200      36300</p>	<p>44</p> <p>400      38200</p>	<p>48</p> <p>200      39400</p>
<p>39</p> <p>ARBESPINE</p> <p>500      34100</p>	<p>43</p> <p>600      37800</p>	<p>47</p> <p>100      39200</p>
<p>38</p> <p>Salle des Tilleuls</p> <p>Eglise de Tiège</p> <p>800      33600</p>	<p>42</p> <p>Chemin de Frahinfaz</p> <p>500      37200</p>	<p>46</p> <p>SPA</p> <p>800      39100</p>
<p>37</p> <p>500      32800</p>	<p>41</p> <p>400      36700</p>	<p>45</p> <p>100      38300</p>



Dimanche 19 juillet 2009

Voiture balai GSM 0496 50 48 06

52

**Arrêt graissage**  
**Source de la**  
**Géronstère**  
 rue Géronstère, 119  
 SPA  
 Tél.087/ 77 03 72

56

COO



1400 8300

60

RAHIER 6

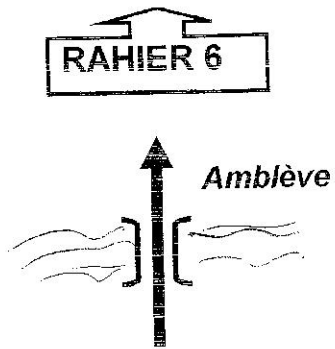

Ambève

1500 16700

51

Source de la  
GERONSTERE

P

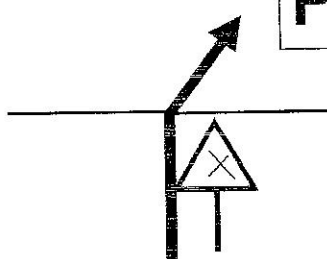

2700 45000

55

COO

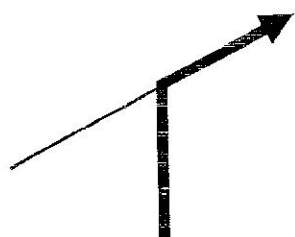

3900 6900

59

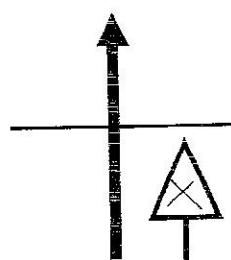

1300 15200

50

La GLEIZE 15

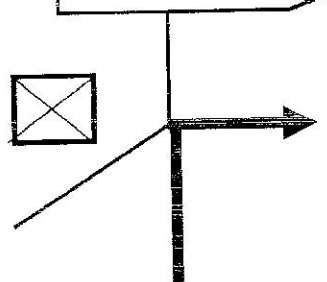

2900 42300

54

ANDRIMONT

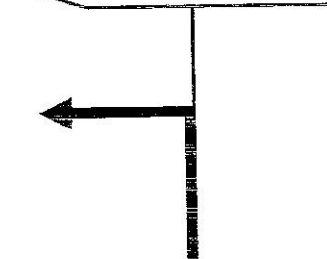

3000 3000

58

7 RAHIER



2300 13900

49

**R.S.P.**  
**Francorchamps**  
**sur 2,9 Km.**

53

La GLEIZE

P

Remise des compteurs à zéro

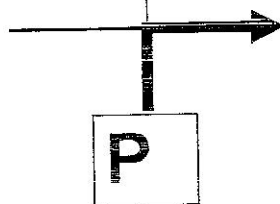

3300 11600

57

REMOUCHAMPS

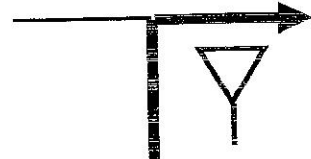





3300 11600

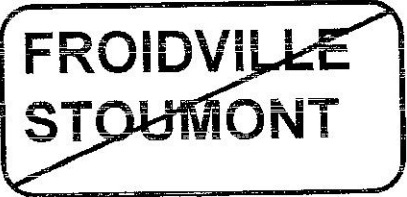
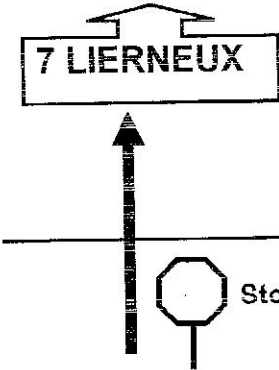
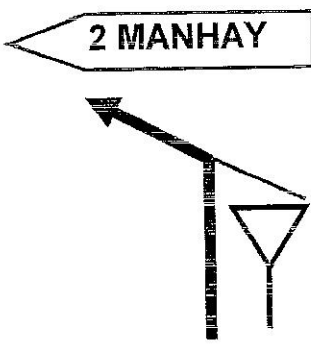
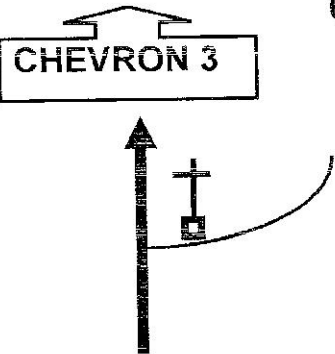

Dimanche 19 juillet 2009

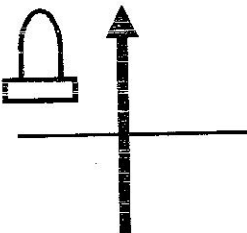
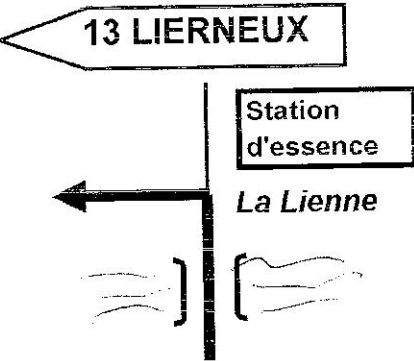
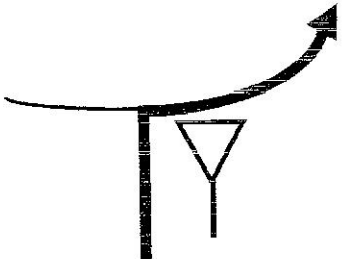
Voiture balai GSM 0496 50 48 06

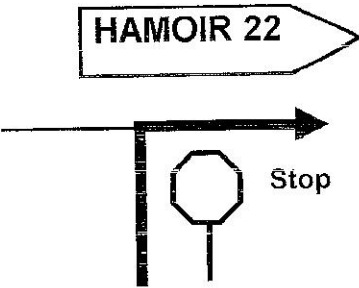
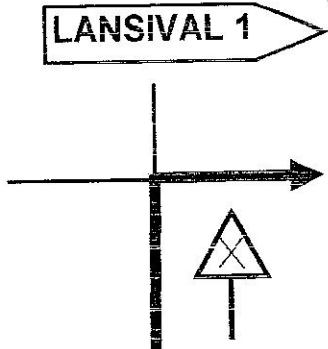
<p>64</p>  <p>800 22100</p>	<p>68</p>  <p>3200 31600</p>	<p>72</p>  <p>4700 42700</p>
<p>63</p>  <p>400 21300</p>	<p>67</p>  <p>2200 28400</p>	<p>71</p>  <p>300 38000</p>
<p>62</p>  <p>4200 20900</p>	<p>66</p>  <p>2600 26200</p>	<p>70</p>  <p>1900 37700</p>
<p>61</p>  <p>1500 23600</p>	<p>65</p>  <p>1500 23600</p>	<p>69</p>  <p>4200 35800</p>



Dimanche 19 juillet 2009







Voiture balai GSM 0496 50 48 06

<p>76</p> <p>Le <b>MIROIR</b></p> <p>P</p> <p>Remise des compteurs à zéro</p>	<p>80</p> <p>Passage très difficile sur 1 km.</p>	<p>84</p> <p>HEYD 3</p> <p>200 14800</p>
<p>75</p> <p>Arrêt de midi au Restaurant "<b>Le MIROIR</b>" rue du Vieux Frêne DOCHAMPS Tél. 084 44 48 10 <b>Bon appétit</b></p> <p>200 54100</p>	<p>79</p> <p>rue du TTA</p> <p>Camping</p> <p>4600 8400</p>	<p>83</p> <p>15 BARVAUX</p> <p>3800 14600</p>
<p>74</p> <p>Le <b>MIROIR</b></p> <p>8800 53900</p>	<p>78</p> <p>EREZEE 7</p> <p>3800 3800</p>	<p>82</p> <p>3 FANZEL</p> <p>600 10800</p>
<p>73</p> <p>R.S.P. Dochamps</p> <p>Café</p> <p>2400 45100</p>	<p>77</p> <p>R.S.P. EREZEE</p>	<p>81</p> <p>Place</p> <p>1800 10200</p>

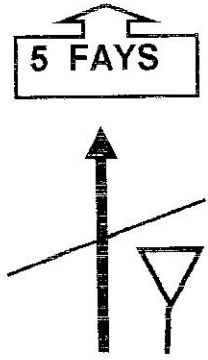
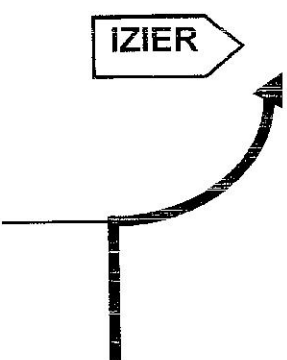
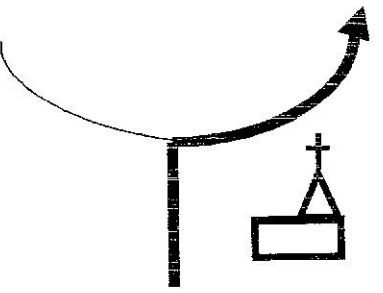

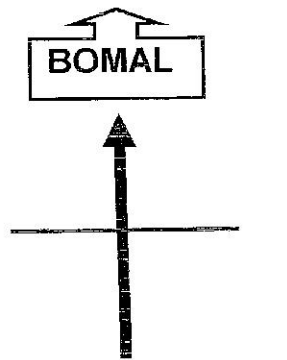
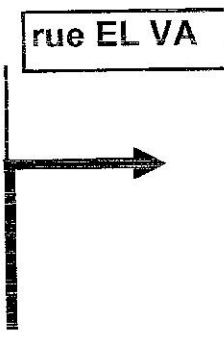
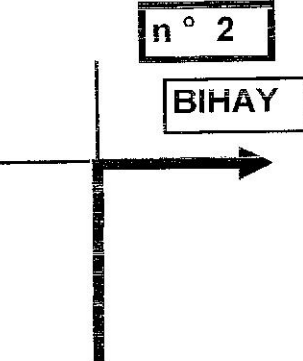
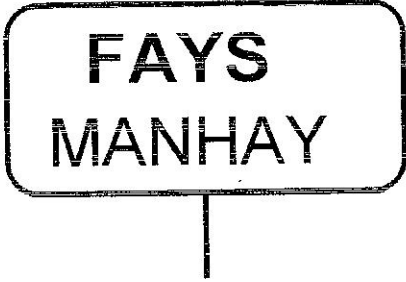
Dimanche 19 juillet 2009

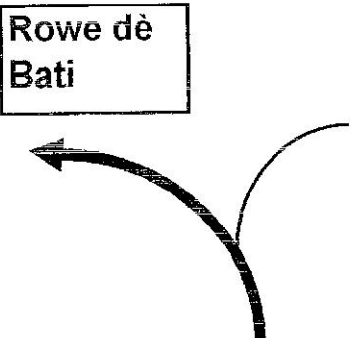
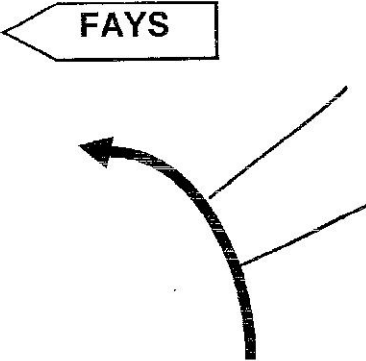
Voiture balai GSM 0496 50 48 06

<p>88</p>  <p>2300      21100</p>	<p>92</p>  <p>1300      27200</p>	<p>96</p>  <p>600      31600</p>
<p>87</p>  <p>500      18800</p>	<p>91</p>  <p>500      25900</p>	<p>95</p>  <p>700      31000</p>
<p>86</p>  <p>400      18300</p>	<p>90</p>  <p>700      25400</p>	<p>94</p>  <p>3100      30300</p>
<p>85</p>  <p>3100      17900</p>	<p>89</p>  <p>3600      24700</p>	<p>93</p> 





Dimanche 19 juillet 2009

Voiture balai GSM 0496 50 48 06

<p>100</p> <p>2550      34850</p>	<p>104</p> <p>2100      2600</p>	<p>108</p> <p>800      13300</p>
<p>99</p> <p>400      32300</p>	<p>103</p> <p>500      500</p>	<p>107</p> <p>5500      12500</p>
<p>98</p>	<p>102</p> <p>34850</p>	<p>106</p>
<p>97</p> <p>300      31900</p>	<p>101</p> <p>Remise des compteurs à zéro</p>	<p>105</p> <p>4400      7000</p>



Dimanche 19 juillet 2009

Voiture balai GSM 0496 50 48 06

<p>112</p> <p>50 16250</p>	<p>116</p> <p>1100 19400</p>	<p>120</p> <p>700 25200</p>
<p>111</p> <p>300 16200</p>	<p>115</p> <p>1600 18300</p>	<p>119</p> <p>1700 24500</p>
<p>110</p> <p>2200 15900</p>	<p>114</p> <p>200 16700</p>	<p>118</p> <p>2600 22800</p>
<p>109</p> <p>400 13700</p>	<p>113</p> <p>250 16500</p>	<p>117</p> <p>800 20200</p>



Dimanche 19 juillet 2009

Voiture balai GSM 0496 50 48 06

124

128

R.S.P.  
SOUMAGNE

ARRIVEE

Cafétariat

P

400

43600

123

127

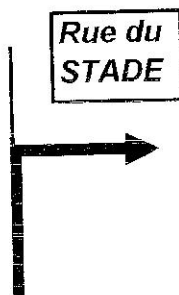
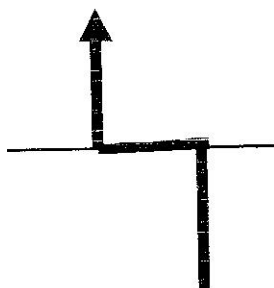

4900

32100

300

43200

122

126

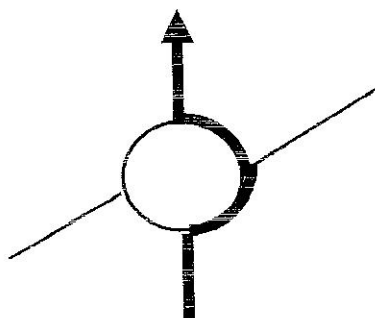
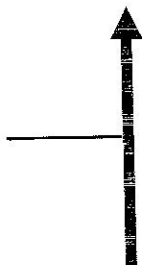

Merci pour votre participation.  
Rendez-vous à Cerexhe-Heuseux le 2 août.  
Tél. 04 387 57 21  
Pierrot DORTHU

400

27200

4500

42900

121

125

NESSONVAUX

HERVE 5

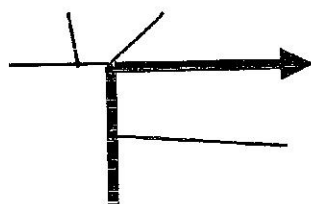
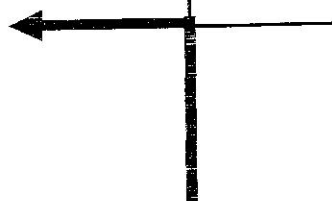

1600

26800

6100